

# JUKOLUX

smarter light. better performance.

## Operating Instructions

Linear EX LED Luminaire  
Series: JUKO ALX



## 1 General Information

### 1.1 Manufacturer

Jukolux Oy  
Yrittäjänkatu 15  
65380 VAASA  
FINLAND

EFC Finland Oy  
Ahmantie 6  
65520 Helsingby  
FINLAND

Phone: +358 401393289  
Internet: [www.jukolux.com](http://www.jukolux.com)  
Email: [info@jukolux.fi](mailto:info@jukolux.fi)

Phone: +358 (0)6 322 6222  
Internet: [www.efc.fi](http://www.efc.fi)  
Email: [info@efc.fi](mailto:info@efc.fi)

#### Quality Assurance Notification No.

19 ATEX Q 003  
IECEX QAR 19.002

### 1.2 Information regarding the operating instructions

The original instructions are the English edition.  
They are legally binding in all legal affairs.

### 1.3 Conformity with standards and regulations

Certificates and EU Declaration of Conformity are available at [www.jukolux.com](http://www.jukolux.com). The device has IECEx approval which can be viewed at <http://iecex.iec.ch/>. Further information about certificates can be asked from the staff of Jukolux Oy.

Document number OI-ALX0001		
Revision	Date	Changes
1	19.5.2023	Added certificate numbers, corrected ex classification details
2	20.6.2023	Changed rated voltage and T -class
3	25.9.2024	Fuses changed and L90 lifespan added

## 2 Explanation of the symbols

### 2.1 Symbols used in these operating instructions

Symbol	Meaning
	Tips and recommendation on the use of the device
	General Danger
	Danger due to explosive atmosphere
	Danger due to energized parts

### 2.2 Warning notes

Warnings must be observed under all circumstances, to minimize the risk due to construction and operation. The warning notes have the following structure:

- Signaling word: DANGER, WARNING, CAUTION, NOTICE
- Type and source of danger/damage
- Consequences of danger
- Taking countermeasures to avoid the danger or damage

#### 2.2.1 DANGER

	<b>DANGER</b>
	Danger to persons. Non-compliance with the instruction results in severe or fatal injuries to persons.

#### 2.2.2 WARNING

	<b>WARNING</b>
	Danger to persons. Non-compliance with the instruction can result in severe or fatal injuries to persons.



2.2.3 CAUTION

	<b>CAUTION</b>
	Danger to persons. Non-compliance with the instruction can result in light injuries to persons.

2.2.4 NOTICE

<b>NOTICE</b>
Avoiding material damage. Non-compliance with the instruction can result in material damage to the device and / or its environment.

2.3 Symbols on the device

Symbol	Meaning
	CE marking according to the currently applicable directive.
	According to marking, device approved for hazardous areas.

### 3 Safety notes

3.1 Operating instructions storage

- Read the operating instructions carefully
- Store the operating instructions at the mounting location of the device
- Observe applicable documents and operating instructions of the devices to be connected

3.2 Safe use

- Read and observe the safety notes in these operating instructions!
- Observe characteristic values and rated operating conditions on the rating and data plates
- Observe additional information plates on the device
- Use the device in accordance with its intended and approved purpose only
- We cannot be held liable for damage caused by incorrect or unauthorized use or by non-compliance with these operating instructions
- Before installation and commissioning, make sure that the device is not damaged

- Work on the device (installation, maintenance, overhaul, repair) may only be carried out by appropriately authorized and trained personnel

### 3.3 Intended Use

The LED linear light JUKO ALX is equipment

- For stationary mounting
- For use in Zones 1, 21, 2, 22 and in the safe area
- Can be used indoors and outdoors
- For lighting areas, work spaces and objects

### 3.4 Modifications and alterations

	DANGER
	<p>Explosion hazard due to modifications and alterations to the device! Non-compliance results in severe or fatal injuries.</p> <ul style="list-style-type: none"> <li>• DO NOT MODIFY OR ALTER THE DEVICE</li> </ul>

## 4 Function and device design

	DANGER
	<p>Explosion hazard due to improper use! Non-compliance results in severe or fatal injuries.</p> <ul style="list-style-type: none"> <li>• Use the device only in accordance with the operating conditions described in these operating instructions</li> <li>• Use the device only for the intended purpose specified in these operating instructions</li> </ul>

### 4.1 Function

For lighting areas, work spaces and objects.

## 4.2 Device design

### JUKO ALX 06

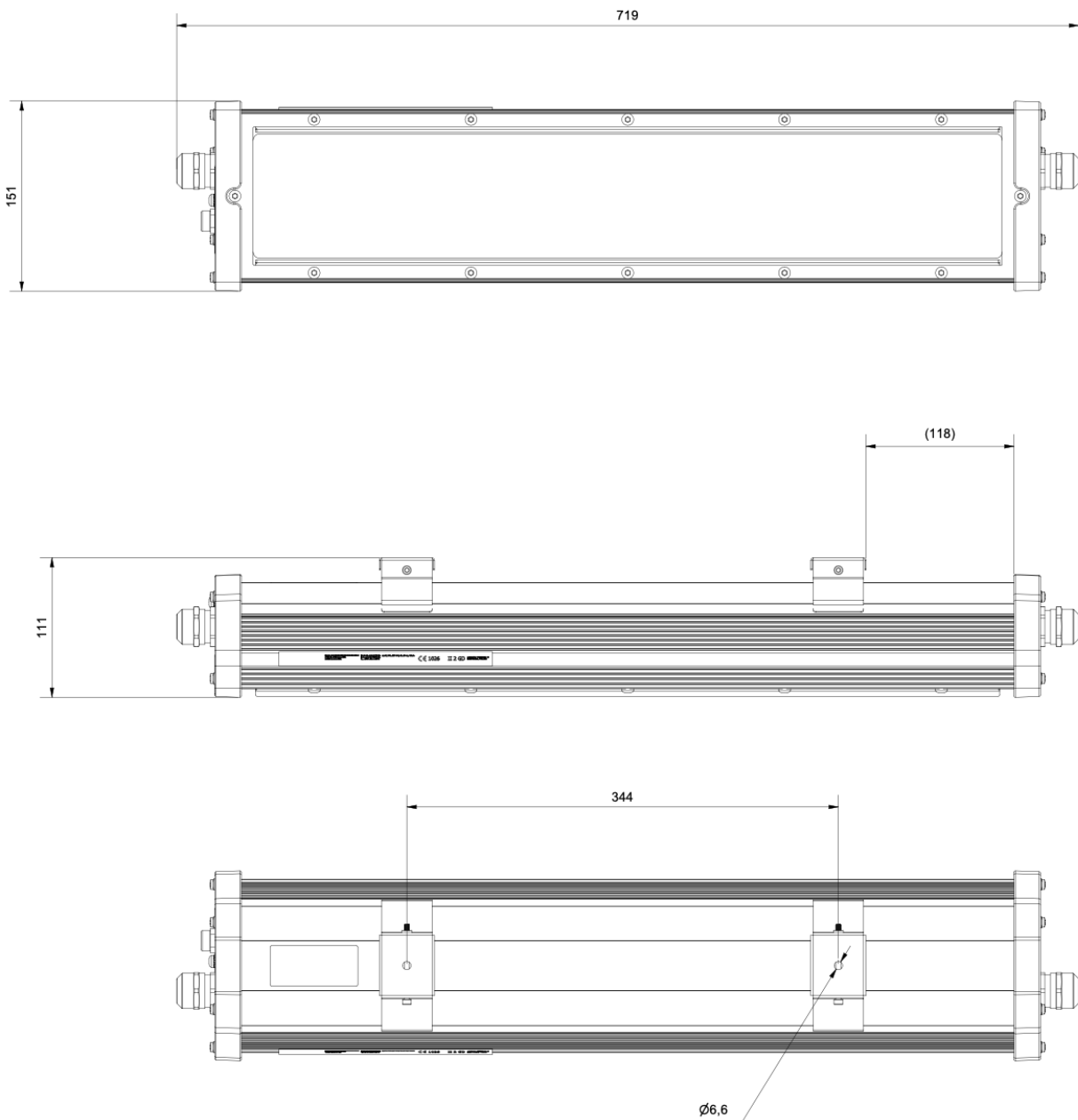

JUKO ALX 12

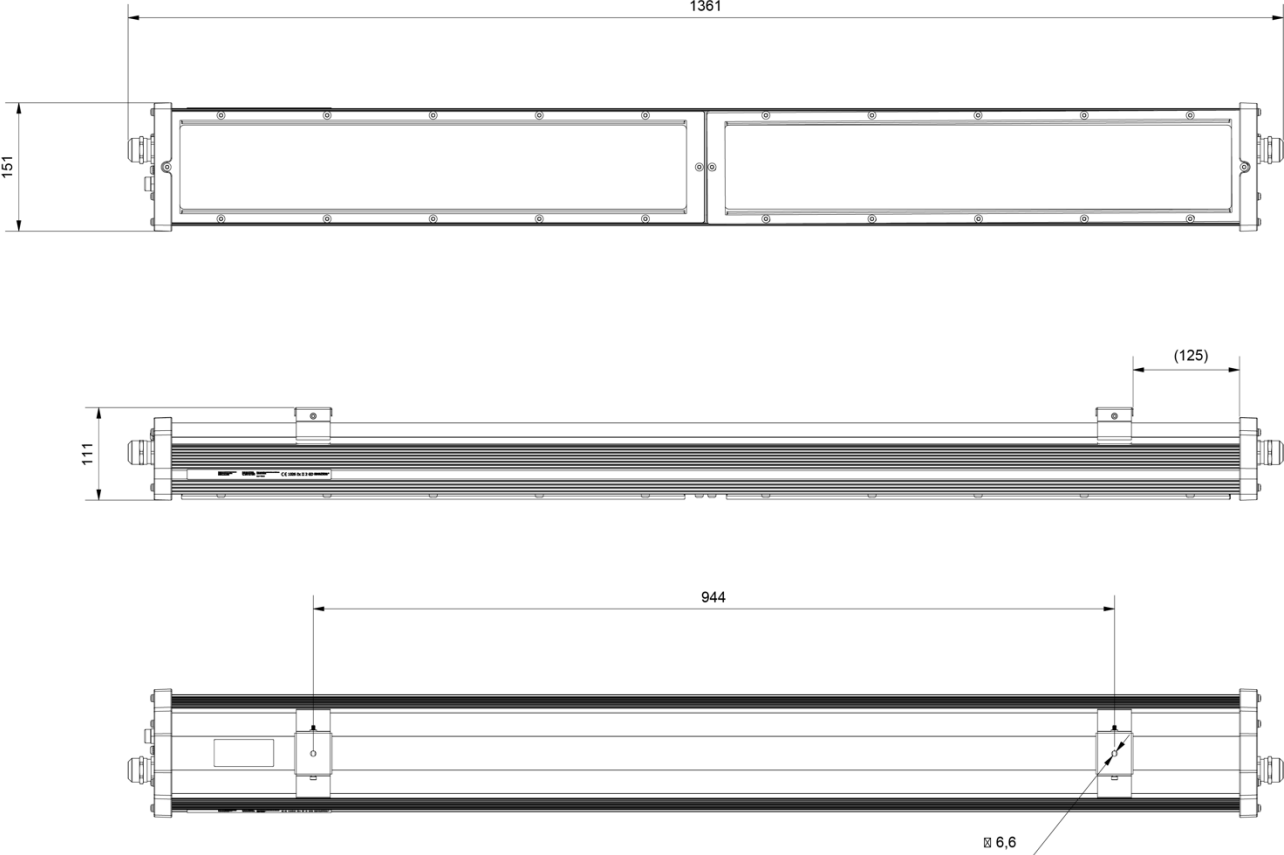

## 5 Technical data

### Explosion protection

<b>Global (IECEX)</b>	
Gas and dust	IECEX FTZU 23.0010X
	Ex eb mb op is IIC T4 Gb
	Ex tb op is IIIC T85°C Db
<b>EUROPE (ATEX)</b>	
Gas and dust	FTZU 23 ATEX 0017X
	⊕ II 2G Ex eb mb op is IIC T4 Gb
	⊕ II 2D Ex tb op is IIIC T85°C Db

	TYPE	Reflector / Beam width
	ALX-xx-xx-060...	60°
	ALX-xx-xx-090...	90°
	ALX-xx-xx-120...	120°

	TYPE	POWER	Ambient Temperature	Temperature class	Max. surface temperature
	ALX-06-M1...	25W	-40°C ... +55°C	T4	85°C
	ALX-06-M2... / ALX-12-M2...	50W	-40°C ... +55°C	T4	85°C
	ALX-12-M4...	100W	-40°C ... +55°C	T4	85°C

### Certifications and certificates

Certificates: IECEX, ATEX

### Technical data

#### Electrical data

<b>Electronic ballast</b>		
Rated Voltage	230 V, 50 / 60 Hz	
Rated Current	Constant current: 150mA	
	Max current output: 180mA	
<b>Inrush Current</b>	I <sub>p</sub> ≤ 50 A, t <sub>p</sub> ≤ 200 μs @ 230 V, 50 Hz	
<b>Max. fittings per Circuit Breaker</b>		
	ALX-06-M1/M2   ALX-12-M2	ALX-12-M4
Type B 10 A	28	14



Type B 16 A	44	22
Type C 10 A	36	18
Type C 16 A	54	27
<b>Power factor</b>	≥ 0.95	
<b>THD</b>	≤ 12 %	

### Luminous characteristics

	ALX-06-M1	ALX-06-M2 / ALX-12-M2	ALX-12-M4
Power consumption (W)	25	50	100
Colour rendering (CRI)	≥ 80	≥ 80	≥ 80
Colour temperature (K)	4000	4000	4000
<b>Wide Beam</b>			
Luminous flux (lm)	4000	8000	16 000
Efficacy (lm/w)	160	160	160

Values apply to  $T_a = +25^\circ\text{C}$ .

Luminous flux decrease at  $T_a = +55^\circ\text{C}$  for all versions

- ≥ 90 % of the nominal value.

### Ambient conditions

Operating temperature range	-40°C ... +55°C
Storage temperature	-40°C ... +80°C

Service Life		$T_a \leq +25^\circ\text{C}$	$+25^\circ\text{C} < T_a \leq +55^\circ\text{C}$
	L90B10C10	100000h	70000h

$L_x B_y C_z$

At the end of the service life:

- Luminous flux decreases by “x” percent
- Up to “y” percent of all luminaires fall below “x”
- Up to “z” percent of all luminaires break down completely

### Mechanical data

Degree of protection	IP66 (IEC 60529)
Protection class	I (with internal PE connection)
IK class	IK08 / IK10 (IEC 62262)
<b>Material</b>	
Enclosure	Anodized aluminum extrusion profile
Coating	Anodized
Seal	EPDM and Silicone
Lamp cover	Borosilicate tempered glass

*Mounting / Installation*

Cable entry	Cable gland (M25/M20)
	Stopping plug (M25/M20)
<b>Connection</b>	
Standard	3-pole (2xL1, 2xN, 2xPE)
	Spring clamp terminals
	1.5 ... 4 mm <sup>2</sup> solid/stranded
	Stripping length: 10 ... 11 mm

## 6 Transport and storage

- Transport and store the device only in the original packaging
- Store the device in a dry place (no condensation) and vibration-free
- Do not drop the device

## 7 Mounting and installation

<b>DANGER</b>	
	<p>Explosion hazard due to incorrect installation of the device! Non-compliance results in severe or fatal injuries.</p> <ul style="list-style-type: none"><li>• Carry out installation strictly according to the instructions and national safety and accident prevention regulations to maintain the explosion protection.</li><li>• Select and install the electrical device so that explosion protection is not affected due to external influences, i.e. pressure conditions, chemical, mechanical, thermal and electric impact such as vibration, humidity and corrosion (see IEC/EN 60079-14).</li><li>• The device must only be installed by trained qualified personnel who is familiar with the relevant standards.</li></ul>

### 7.1 Dimensions / fastening dimensions

Dimensional drawings (All dimensions in mm) – Subject to Alterations

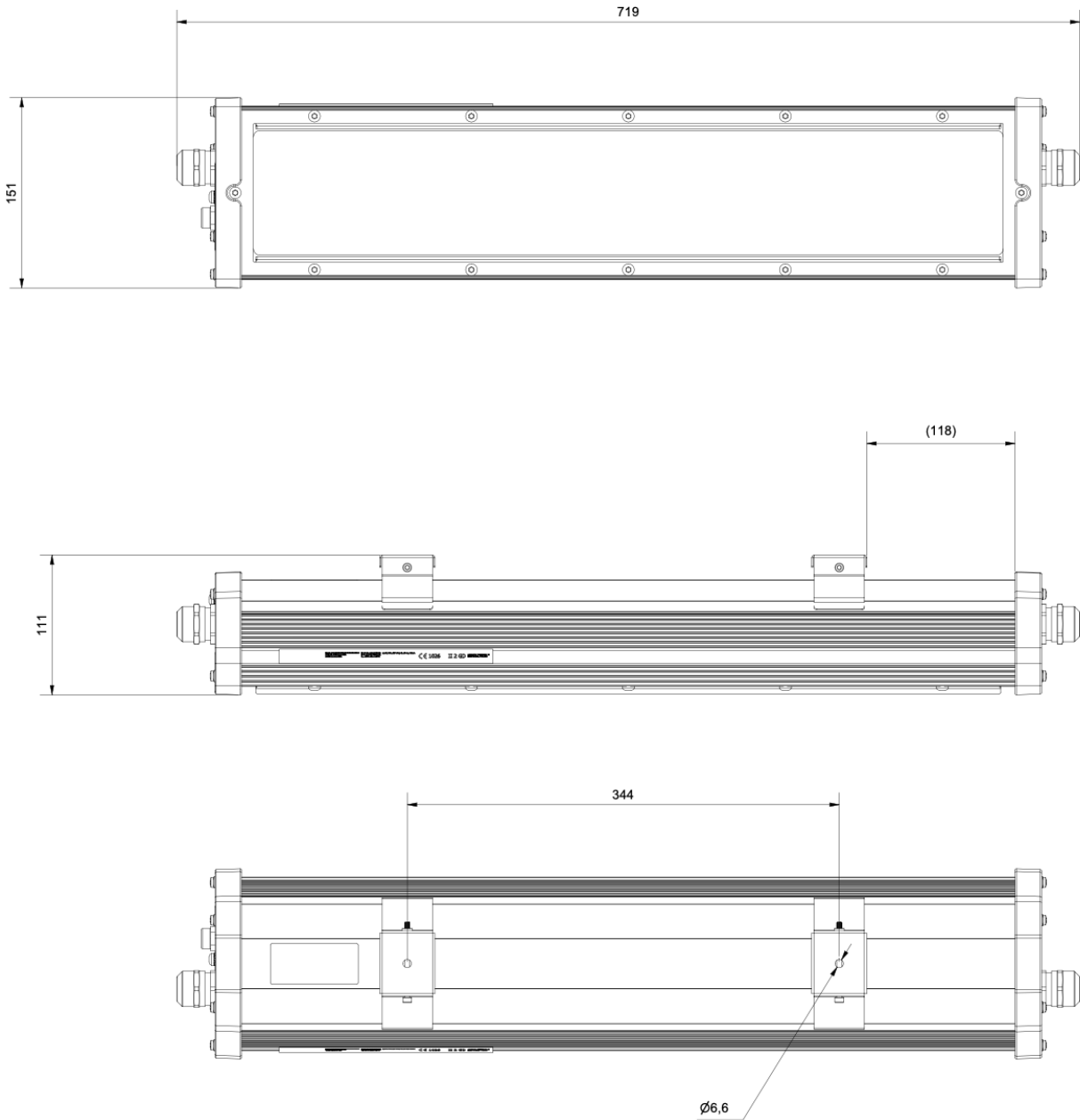

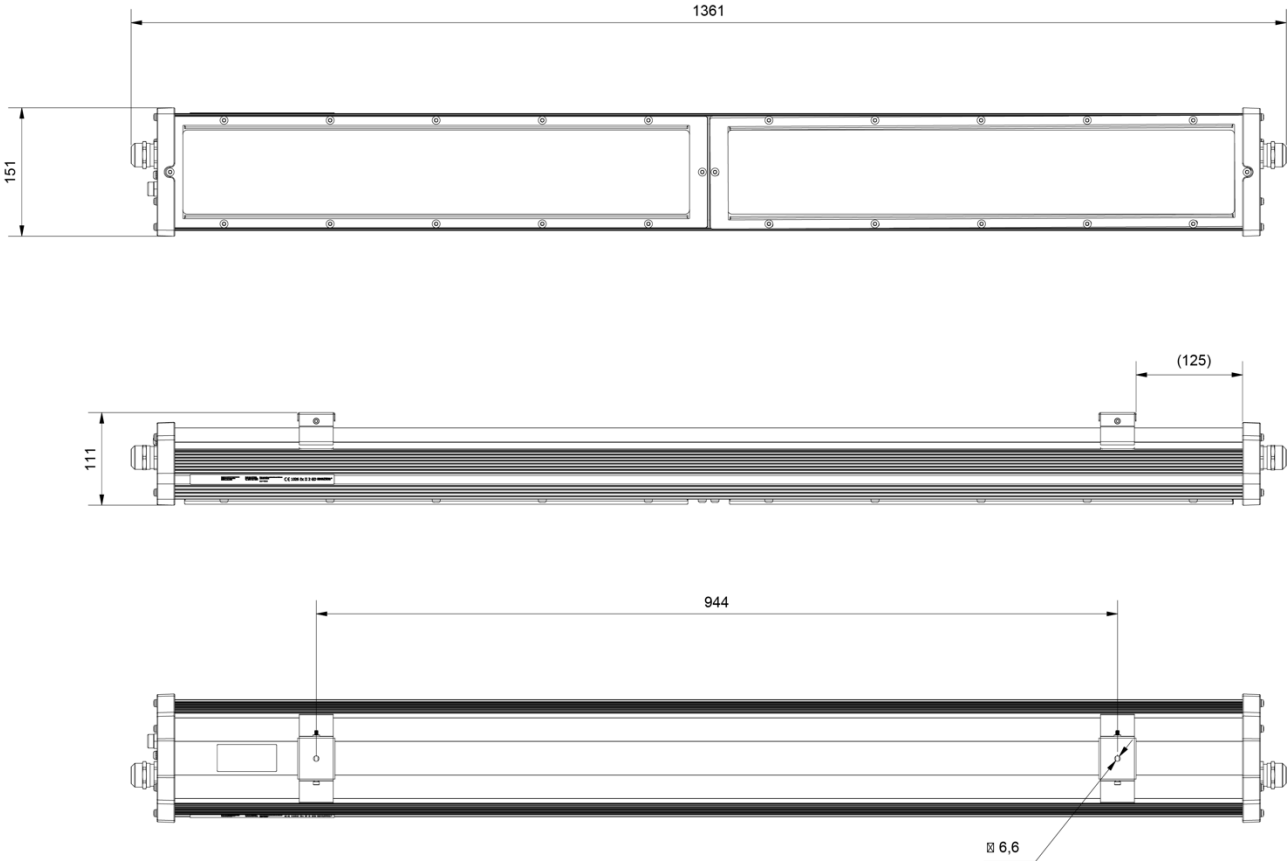

### 7.2 Mounting / dismounting, operating position

	DANGER
	<p>Explosion hazard due to inadmissible heating! Non-compliance results in severe or fatal injuries.</p> <ul style="list-style-type: none"> <li>• Avoid external heat sources and/or direct sunlight (risk of change of temperature class or change of maximum permissible surface temperature).</li> <li>• Do not exceed the maximum ambient temperature due to external heat sources (premature failure of equipment).</li> </ul>

- Suitable for use indoors and outdoors
- Designed for wall, ceiling, pole mounting with different brackets

### 7.3 Installation

#### 7.3.1 Opening and closing of the enclosure

	DANGER
	<p><b>Only enclosure allowed to be opened is shown below. <u>No other enclosures are allowed to be opened.</u></b></p> <ul style="list-style-type: none"> <li>• Accidents or fatal injury are almost certain to happen</li> </ul>

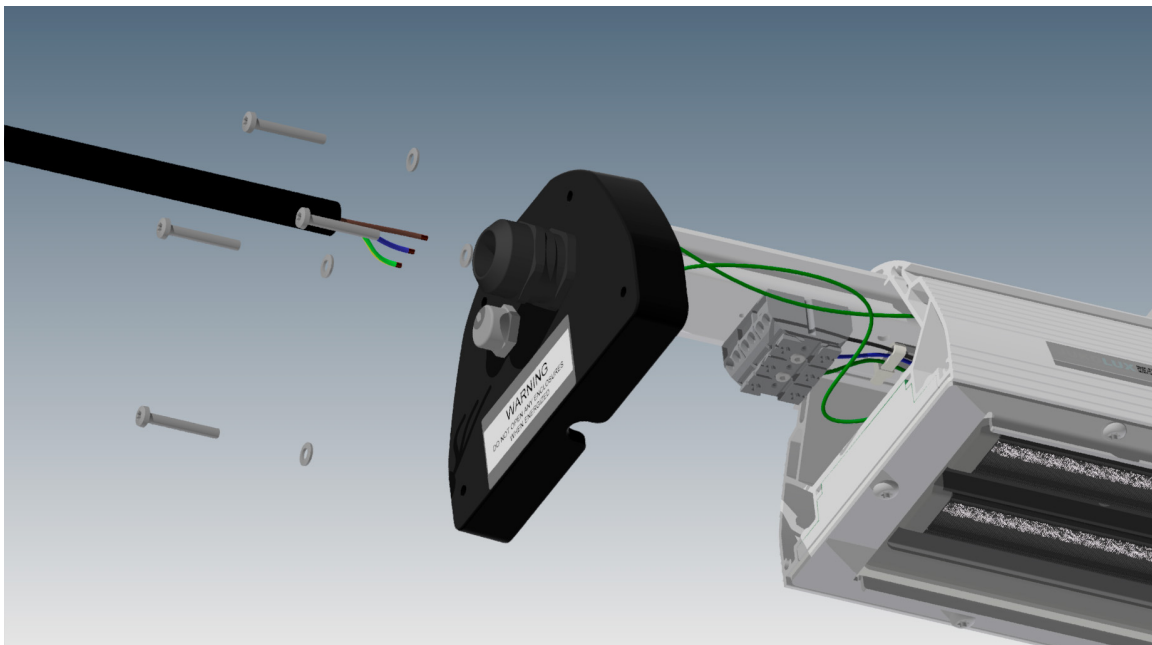

	DANGER
	<p><b>DO NOT OPEN ANY ENCLOSURES WHEN ENERGIZED! Accidents or fatal injury are almost certain to happen!</b></p> <ul style="list-style-type: none"> <li>• Only open the enclosure in switched-off state.</li> </ul>

	DANGER
	Risk of electric shock due to improper opening! Non-compliance results in severe or fatal injuries. <ul style="list-style-type: none"> <li>• Open only in switched-off state.</li> </ul>

### 7.3.2 Cable entries

	DANGER
	All special conditions of use for certified cable glands must be fulfilled.

Luminaires that are provided with cable entries and stopping plugs supplied by Jukolux Oy must be tightened using the following values:

		Tightening torque (upper body)	Tightening torque (cap)
Cable Entry	M25 x 1.5	2.5Nm	9.0Nm
Cable Entry	M20 x 2.5	2.0Nm	2.5Nm
Stopping plug	M25 x 1.5	1.5Nm	

#### ***Luminaires with approved cable entries and stopping plugs not supplied by Jukolux Oy:***

	DANGER
	Explosion hazard due to impermissible cable entries and stopping plugs! Non-compliance results in severe or fatal injuries. <ul style="list-style-type: none"> <li>• Only use separately certified cable entries and stopping plugs.</li> </ul>

Please observe the following:

- The required dust resistance!
- The required type of protection!
- The required temperature resistance!
- The IP degree of protection according to the rating plate!
- The operating instructions of the cable entries and stopping plugs!
- The required tightening torques!
- The range of the permissible cable diameter!

### 7.3.3 Electrical connections

Electrical connection

Observe the maximum clamping possibility of the connecting terminals (see technical data chapter)

**Note:**

- Clamping must be carried out precisely
- Do not clamp any part of the conductor insulation
- Do not interchange the conductors
- Observe the technical regulations when connecting the conductor
- Clamp the conductor firmly

**Connection terminals****Standard:**

Push-in Cage Clamp

**Clamping range:**1.5mm<sup>2</sup>...4mm<sup>2</sup> solid and finely stranded (2 free clamping units per pole available)**Stripping length:**

10 ... 11 mm

L1, L2       = phase  
 N            = neutral conductor  
 PE          = protective conductor

## 8 Commissioning

	DANGER
<p>Explosion hazard due to incorrect installation! Non-compliance results in severe or fatal injuries.</p> <ul style="list-style-type: none"> <li>• Check the device for proper installation before commissioning.</li> <li>• Comply with national regulations.</li> </ul>	

**Before commissioning, ensure the following:**

- Check the mounting and installation
- Inspect enclosure for damage
- If necessary, remove foreign bodies
- If necessary, clean the connection chamber
- Check if the conductors have been inserted correctly
- Check if all screws and nuts have been tightened firmly
- Check whether all the cable entries and stopping plugs have been tightened firmly
- Check if all conductors have been clamped firmly
- Check if the line voltage and the rated operational voltage are consistent
- Check if the permissible conductor diameter for the corresponding cable entries have been used
- Check if the device is closed according to regulations



- Check whether the bracket mounting & cover mounting screws are tightened with proper torque

NOTICE	
Malfunction or device damage caused by condensation. Non-compliance can result in material damage!	
<ul style="list-style-type: none"> <li>• Operate the luminaire continuously or periodically over extended periods of time</li> <li>• Avoid thermal bridges</li> </ul>	

## 9 Maintenance and repair

WARNING	
	Risk of electric shock or malfunctioning of the device due to unauthorized work! Non-compliance can result in severe injuries and material damage.
<ul style="list-style-type: none"> <li>• Work performed on the device must only be carried out by appropriately authorized and qualified electricians.</li> <li>• To be carried out as per EN60079-17 and as per EN60079-19.</li> </ul>	

DANGER	
	Explosion hazard due to hot built-in components! Accidents or fatal injury are almost certain to happen!
<ul style="list-style-type: none"> <li>• Only open the enclosure in switched-off state.</li> </ul>	

### 9.1 Maintenance and repair

DANGER	
	Explosion hazard due to hot built-in components! Accidents or fatal injury are almost certain to happen!
<ul style="list-style-type: none"> <li>• Only open the enclosure in switched-off state.</li> </ul>	

NOTICE	
Moisture inside the connection chamber can result in damage to electric and electronic components.	
<ul style="list-style-type: none"> <li>• Remove moisture with a cloth</li> <li>• Determine the source and eliminate the cause!</li> <li>• Avoid condensation and thermal bridges!</li> </ul>	

	Observe the relevant national regulation in the country of use!
---	---

Determine the type and extent of inspections in compliance with the relevant national regulations. Adapt inspection intervals to the operating conditions.

The following tests and measures must be carried out during regular maintenance.

CHECK	MEASURES
The permissible ambient temperature	If exceeding the permissible ambient temperature or falling below, the device must be taken out of operation
The enclosure components for formation of cracks and damage	The device must be taken out of operation
Its intended use	If the device is not used according to its intended use, it must be taken out of operation
If the conductors are clamped properly	Clamp loose conductors tightly
The cables for ageing and damage	Replace damaged or aged cables
The seals for ageing and damage	If seals are damaged, the device must be taken out of operation
The outside of the luminaire for pollution	Clean the luminaire

### 9.1.1 Cleaning

Clean the device only with a cloth, brush, vacuum cleaner or similar items. When cleaning with a damp cloth, use water or mild, non-abrasive, non-scratching cleaning agents. Do not use aggressive detergents or solvents.

### 9.2 Repair

	<b>DANGER</b>
	<p>Explosion hazard due to improper repair!                  Non-compliance results in severe or fatal injuries.</p> <ul style="list-style-type: none"> <li>REPAIR WORK ON THE DEVICES MUST BE PERFORMED ONLY BY JUKOLUX OY</li> </ul>

### 9.3 Returning of the device

Contact directly Jukolux Oy’s customer service. Contact information can be found in “www.jukolux.com > contact”.

## 10 Disposal

Observe national and local regulations and statutory regulation regarding disposal. Separate materials when sending it for recycling. Ensure environmentally friendly disposal of all components according to the statutory regulations.

## 11 Accessories and spare parts

### NOTICE

Malfunction or device damage to the device due to the use of non-original components. Non-compliance can result in material damage.

- Use only original accessories and spare parts from Jukolux Oy.

See more details regarding accessories and spare parts from “[www.jukolux.com](http://www.jukolux.com)”.